

# **AURA** E2 heater

Installation and operating instructions



**MONDEX**

# TABLE OF CONTENTS

<b>1</b>	<b>General safety instructions</b>	<b>3</b>
<b>2</b>	<b>AURA heater</b>	<b>4</b>
<b>3</b>	<b>Heater assembly and installation</b>	<b>4</b>
	Stacking the stones	5
<b>4</b>	<b>Technical specifications</b>	<b>6</b>
	Heater power and voltage	6
	Heater dimensions	6
	Required amount of stones	6
	Minimum distances to inflammable material	6
<b>5</b>	<b>General instructions for users of AURA heaters</b>	<b>7</b>
	Note	7
	Installation cable	7
	Additional connection options	7
<b>6</b>	<b>Things to keep in mind when using the heater</b>	<b>7</b>
	First heating	7
	Sauna room	7
	Temperature control	7
	Heating time	7
	Water thrown on heater	7
	Sauna room structure	8
<b>7</b>	<b>Wall mount installation</b>	<b>8</b>
<b>8</b>	<b>Installation instructions</b>	<b>9</b>
	Heater installation	9
	Installation instructions for the thermostat and controller	10
<b>9</b>	<b>Wiring diagram</b>	<b>11</b>
	Controller card wiring, heater	11
	Controller card wiring, controller	11
<b>10</b>	<b>Heater control and operation</b>	<b>12</b>
	Switching on the heater	12
	Starting the heating process	12
	Timing of the heating process	12
	Starting the heating	12
	Stopping the heating or timing process	13
	Quick start of the heating process	13
	Parental control	13
	Error codes	13
<b>11</b>	<b>Troubleshooting</b>	<b>14</b>
	Heater does not heat up	14
	Warnings	14
<b>12</b>	<b>Warranty and maintenance</b>	<b>15</b>
	Warranty	15
	Maintenance and spare parts	15
	Natural stone as material	15
	Changing the heater stones	15
	<b>Heater maintenance history</b>	<b>16</b>



# 1 GENERAL SAFETY INSTRUCTIONS

To ensure safe use of the sauna, please read these safety instructions first!



- Electrical connections may only be made by an electrician with a valid installation authorisation in accordance with the current regulations.
- The Mondex electric heater is suitable for use in a family sauna, one (1) heater per sauna room. Retain the installation and operating instructions for further reference.
- Always check the adequacy of the fire protection distances!
- Failure to observe the connection instructions may create a fire hazard!
- Always check the sauna room before switching the heater on!
- Always check that the controller has switched the heater off after the set time period!
- Due to the risk of fire, do not use the sauna to dry clothes or laundry.
- Exercise caution with a hot heater, because the heater stones and metal parts become very hot and can cause burns.
- The steam rising from the heater is hot and can cause burns.
- Children, disabled and ill persons using the sauna should be supervised.
- Children may not play with the device.
- A child must not carry out any cleaning or maintenance unattended.
- Benches and floors may be slippery, so move around the sauna with caution.
- Do not go to a hot sauna under the influence of narcotic substances (alcohol, drugs, narcotics, etc.)
- A stone compartment with too few stones or filled improperly creates a fire hazard!
- Covering the heater creates a fire hazard.

This device may be used by children who are 8 years of age or older, as well as by persons whose physical, sensory or mental abilities have deteriorated or who lack of experience and knowledge, only under supervision or when they have been instructed on the safe use of the device and they understand the hazards associated with using the device.

This device complies with the requirements of: 

Mondex pursues an active policy of product development and continuous improvement. For this reason, Mondex reserves the right to make changes relating to the design and technical specifications of their products without prior notice.

## 2 AURA HEATER

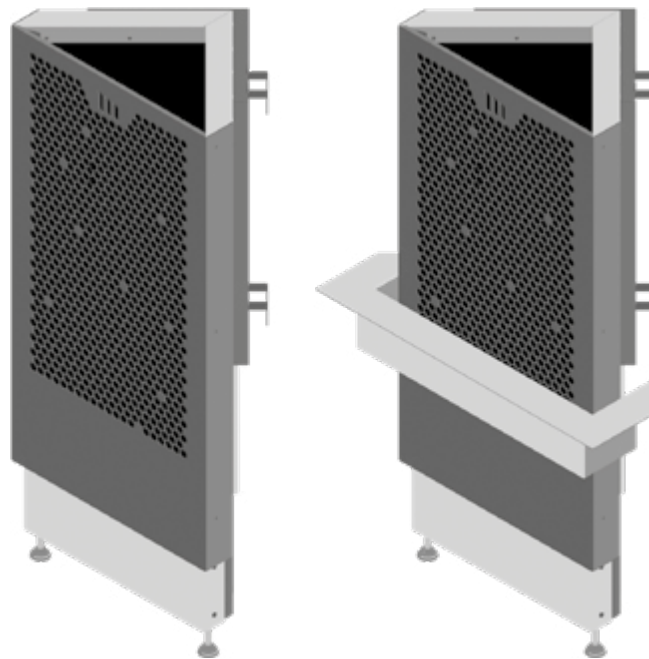

## 3 HEATER ASSEMBLY AND INSTALLATION

### Heater assembly

1. Store the heater in its original package in an upright position and in a warm and dry location until it is installed.
2. The package includes the heater, thermostat sensor, electronic controller and the required cables. Inspect the heater components visually. If you notice any discrepancies, please contact the store from which you purchased the heater. Do not expose heater parts to blows and denting when taking it out of the package. The sauna's floor surface should also be properly protected before you begin the installation.
3. Do not lift the heater by the jacket.
4. An electrician should connect the wires before the heater is installed. If the heater is to be embedded in the bench structure, it must be lowered through the benches before making the electrical connections. If needed, the position of the heater can be fine-tuned by using the adjustable legs. Observe the safety distances between the heater and any inflammable material in accordance with the table on page 6.
5. The heater is installed so that it leans against a wall using the bracket provided (see the dimensions on page 8).
6. To facilitate installation, adjust the heater's feet so that they extend out by 8–9 cm (at least by 5 cm). Install the heater on the floor and adjust the feet so that the heater stands upright.

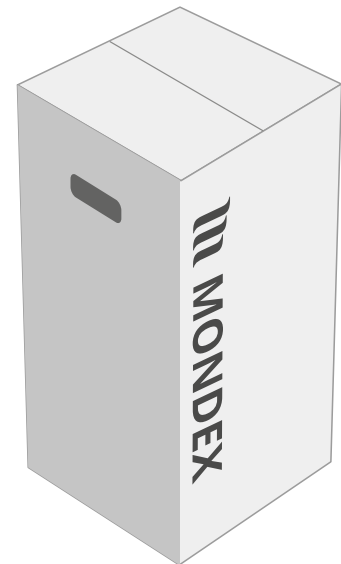

**NOTE!** Remove all plastic film before using the heater.

## Stacking the stones

The suitable stone size is 5–10 cm in diameter.

### Use protective gloves.

- Only use stones with rough cutting surfaces, intended for sauna heaters. Suitable stone materials include peridotite, olivine diabase, and olivine.
- The use of ceramic “stones” and soft soapstone objects is forbidden. It may damage the heating resistors.
- **Rinse any dust off of the heater stones before stacking them in the heater.**

When stacking the stones inside the Aura heater, ensure that the resistors remain upright and straight. Do not bend the resistors so that they are in contact with the metal structures of the heater.

**NOTE! Do not remove the bands around the resistors. If there are two bands, one of them is located at approximately 20 cm from the bottom and another approximately 10–15 cm from the top. They keep the resistors apart from each other and prevent them from deteriorating prematurely.**

Ensure sufficient air circulation around the resistors by leaving spaces between the stones stacked between the resistors. If the stones are stacked too tightly in the middle section, it will extend the heating process and may result in the premature failure of the resistors.

The resistors should be surrounded by stones on all sides.

**Note! Ensure that the resistors do not touch the heater’s frame anywhere. There must always be a stone between a resistor and the frame.**

Do not make a heap of stones on top of the heater!

### Do not use the heater without the stones!

Dents caused by the user are not covered by Mondex’s warranty or other product liability. When stacking the stones, be careful not to dent the heater’s metal surfaces to avoid damaging them.

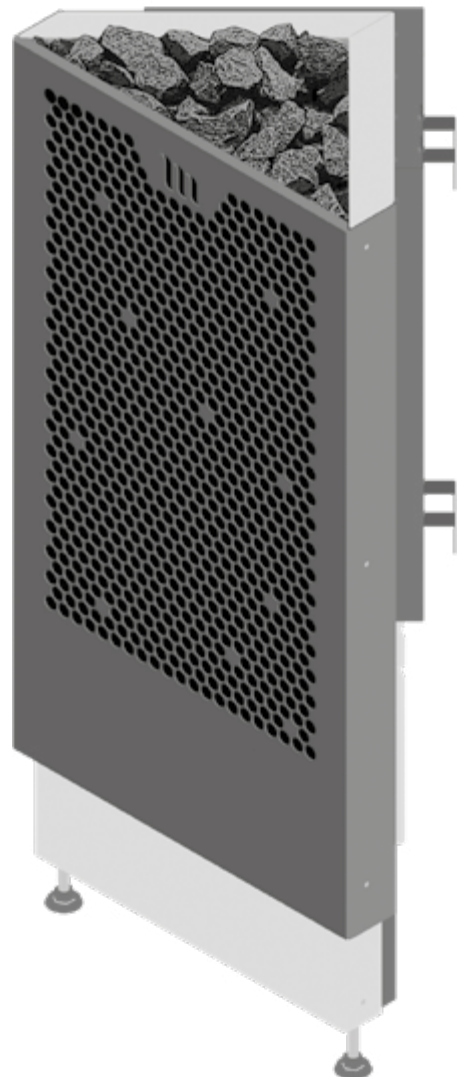
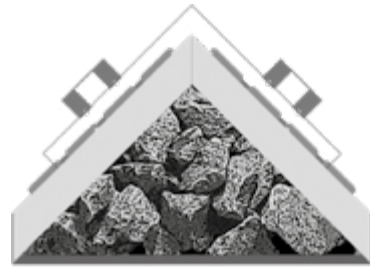

## 4 TECHNICAL SPECIFICATIONS

HEATER	AURA 6.6	AURA 9.0
Power	6.6 kW	9.0 kW
Voltage	400 V 3N~	400 V 3N~
Connecting cable	5 x 1,5 mm <sup>2</sup>	5 x 2,5 mm <sup>2</sup>
Fuse	3 x 10 A	3 x 16 A
Height (mm)	1010	1010
Width (mm)	405	405
Depth (mm)	310	310
Sauna size	5-9 m <sup>3</sup>	8-15 m <sup>3</sup>
Amount of stones	70 kg	70 kg

### MINIMUM DISTANCES TO INFLAMMABLE MATERIAL

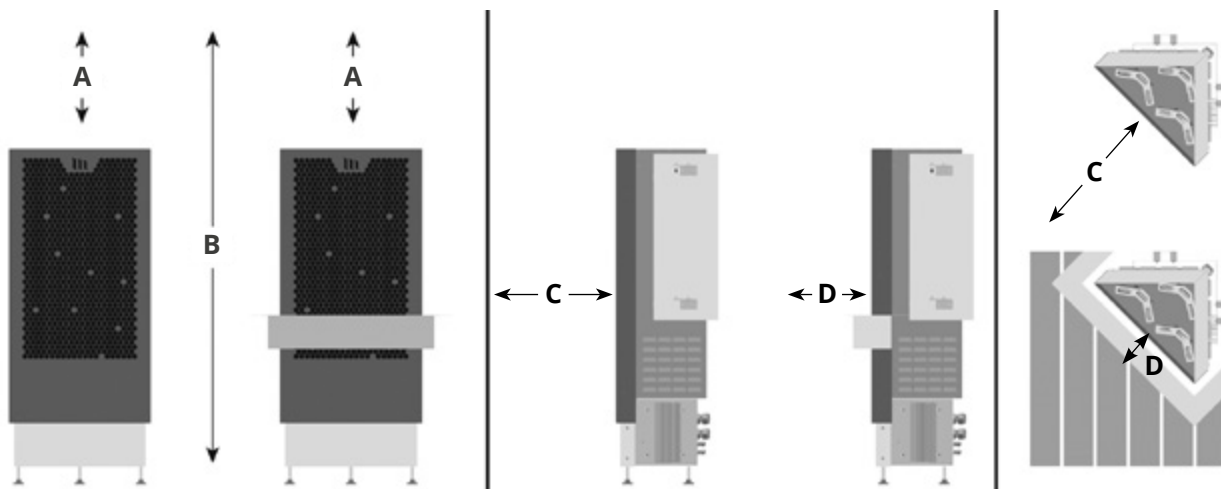

MODEL	A	B	C	D
AURA 6.6	900	2000	100	75
AURA 9.0	900	2,000	120	75

**NOTE!** Ensure that when installing the safety collar, dimension **D** is measured from the front surface of the heater to the bench structures!

## 5 GENERAL INSTRUCTIONS FOR USERS OF AURA HEATERS

### Note

Electrical connections may only be made by an electrician with a valid installation authorisation according to the current regulations. The Aura electric heater is suitable for use in a family sauna, one (1) heater per sauna room. Retain the installation and operating instructions for further reference.

### Installation cable

Use rubber cable H07RN-F as a connection cable.

### Additional connection options

Control of electric heating with the heater: The electric heating control cable is brought directly to the heater's junction box and further to the heater's terminal block with a rubber cable that is dimensionally identical to the incoming cable.

**NOTE! Failure to observe the connection instructions may cause a fire hazard!**

**NOTE! Remove all plastic film before using the heater!**

## 6 THINGS TO KEEP IN MIND WHEN USING THE HEATER

### First heating

During the first heating, the resistors may emit fumes. Therefore, ensure that the room is properly ventilated. **NOTE! Please also read the user instructions for the controller!**

### Sauna room

Always check the sauna room before switching the heater on! Always make sure that the timer has switched the power off after the set time period!

### Temperature control

The temperature is adjusted at the controller (see page 12). The actual heating time depends on the dimensions, structure and thermal insulation of the sauna. The temperature in the sauna room can be maintained at the desired level with the thermostat. If the temperature of the sauna room becomes dangerously high for any reason, the overheating protector will switch the heater's power off. The cause of overheating must always be investigated. The power can be switched on again by pressing the overheating protector reset button (see page 17).

### Heating time

An excessive heating time consumes energy and does not improve the steaming properties. The best steam is achieved by keeping the sauna's heating time relatively short, at about 30–60 min., according to the size of the sauna and the heater's power. The size of the sauna, the glass door, windows, or materials used may require a longer heating time.

### Water thrown onto the heater

We recommend using hand warm water. The water should be fresh household water. Throwing the water onto the heater sides / lower stones generates softer steam. If you want steam that feels hotter and more intense, pour plenty of warm water on top of the heater all at once. **Do not use sea water or chlorinated water.**

## Sauna room structure

The sauna and its ceiling, in particular, should have good thermal insulation, as heat tends to escape through the ceiling. Due to the moisture, we recommend that you use aluminium paper. The size of the heater should be selected according to the size of the sauna (in cubic metres). In addition to calculating the power need for the regular sauna structure (glass wool-foil-wood), the following should be taken into consideration. If the sauna has any uninsulated wood, tile or concrete surfaces or the walls are made of logs, the heater power needs to be increased. For every uninsulated square metre, the heater power need increases by the same amount as if increasing the space volume by 1.2 m<sup>3</sup> and on timber surfaces by 1.5 m<sup>3</sup>. The factor for glass surfaces (glass walls, doors and uninsulated stone surfaces) is also 1.2 m<sup>3</sup> per square metre. In borderline cases, you should choose a heater with higher power.

The sauna needs efficient ventilation for a good oxygen level and a sufficient amount of fresh air. The air in the sauna needs to change at least 6 times per hour. For a sauna with an electric heater, mechanical ventilation is the most convenient ventilation method. The supply air should be provided through an inlet located 500 mm, at a minimum, above the heater, either on the wall or in the ceiling. NOTE: the distance of an undirected inlet air valve from the temperature sensor must be at least 1,000 mm, while the distance of an inlet air valve directed away from the sensor must be at least 500 mm. The exhaust valve should be placed on the opposite wall, as far away from the heater and as close to the floor level as possible. It is highly recommendable to install an exhaust air valve in the ceiling as well for an easier removal of moisture after sauna sessions.

For more information, refer to the construction instructions and building regulations.

## 7 WALL MOUNT INSTALLATION

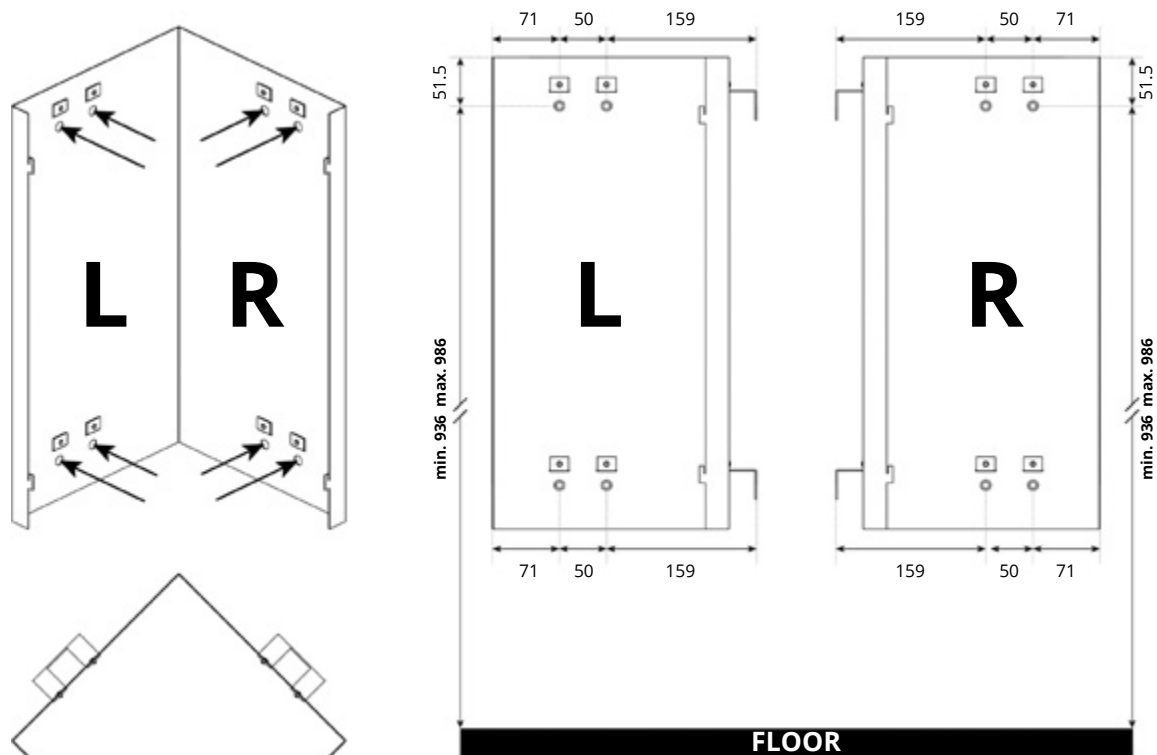

See page 6 for the heater's minimum distances to inflammable materials.

**NOTE!** Keep in mind that the adjustable feet add to the total height of the heater.



## 8 INSTALLATION INSTRUCTIONS

### Installation of external control and sensor

The type E2 heater package includes:



Controller



Temperature sensor

Reinforcing plate



Plastic clip



Cover plate



Control panel



The wall-mounted sensor is placed above the heater.

The temperature sensor must be installed so that it cannot be affected by inlet air.

Place the sensor the following way: 10 cm in a vertical distance from the ceiling, and 10 cm in a horizontal distance from the heater (compare sketch on page 10).

Place the reinforcing plate between the wall/box and the plastic clip.

The plastic clip is either mounted to the wall using three screws or affixed to the bottom of the mounting box. The plastic clip is covered first with a cover plate and finally with the control panel. The length of the sensor cable is 10 m. Cut the excess wire and connect the other end to the heater. When installing the control panel, make sure that the cables do not become detached or bend.

# INSTALLATION INSTRUCTIONS FOR THE THERMOSTAT AND CONTROLLER

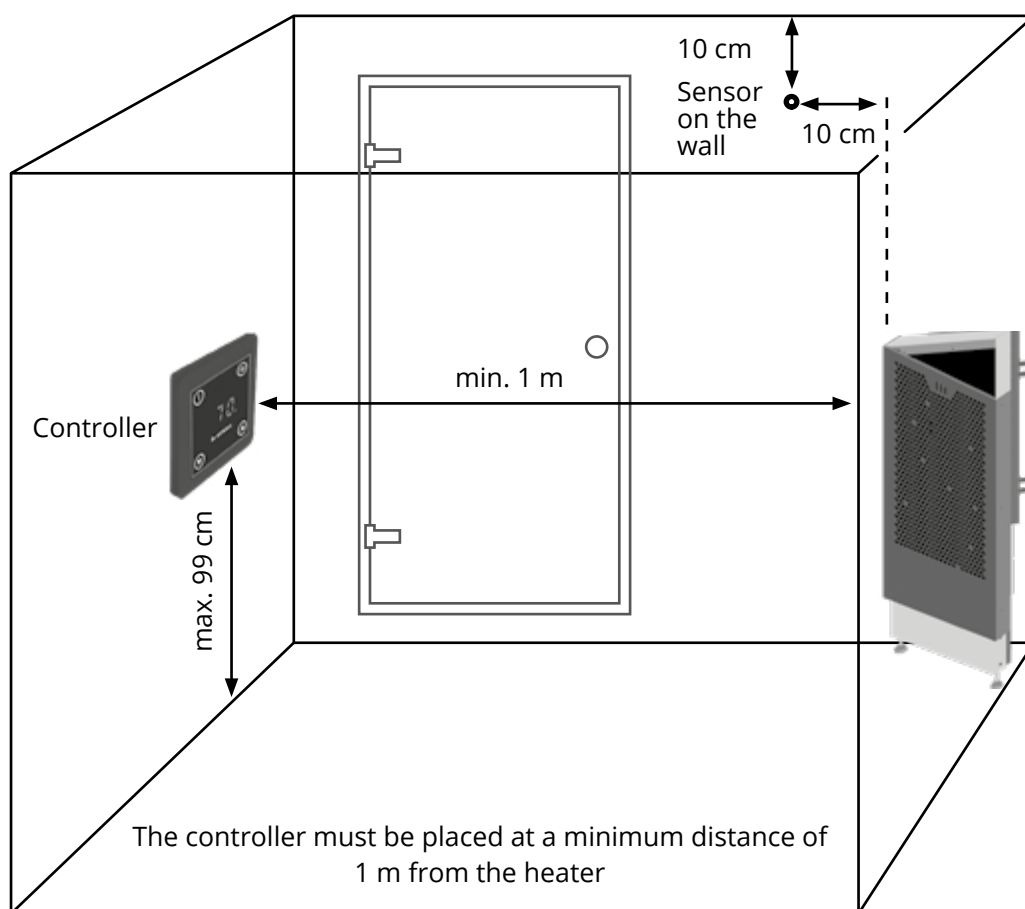
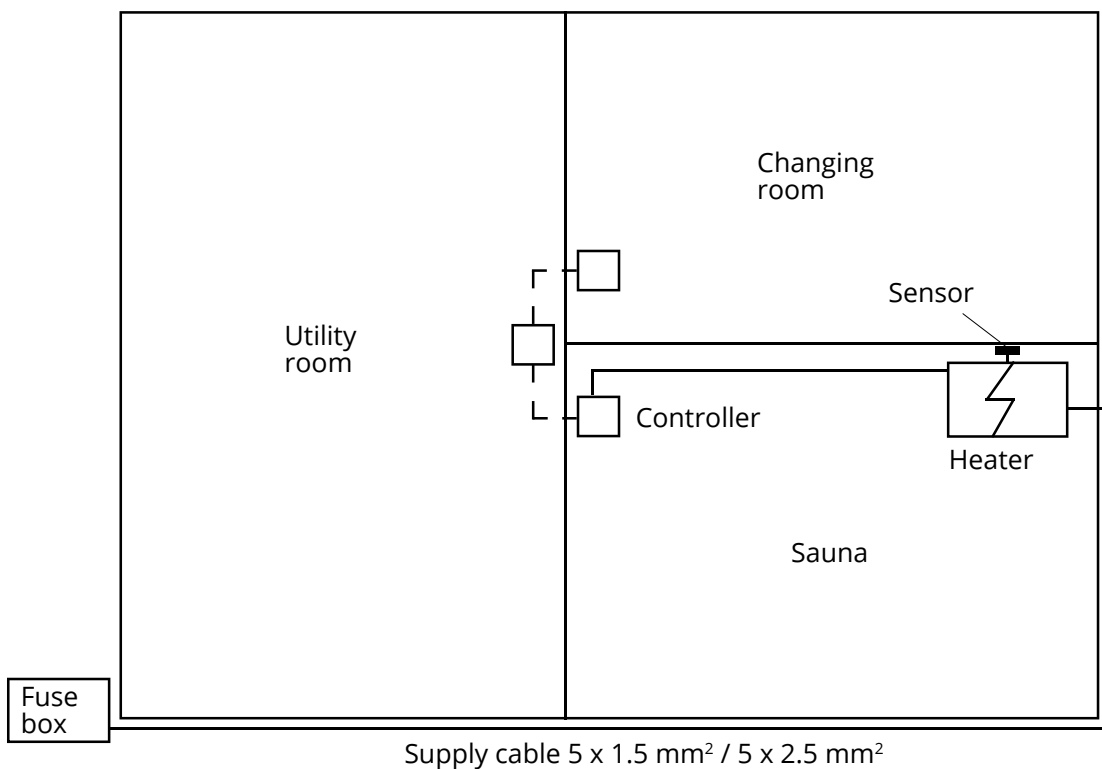

## 9 WIRING DIAGRAM

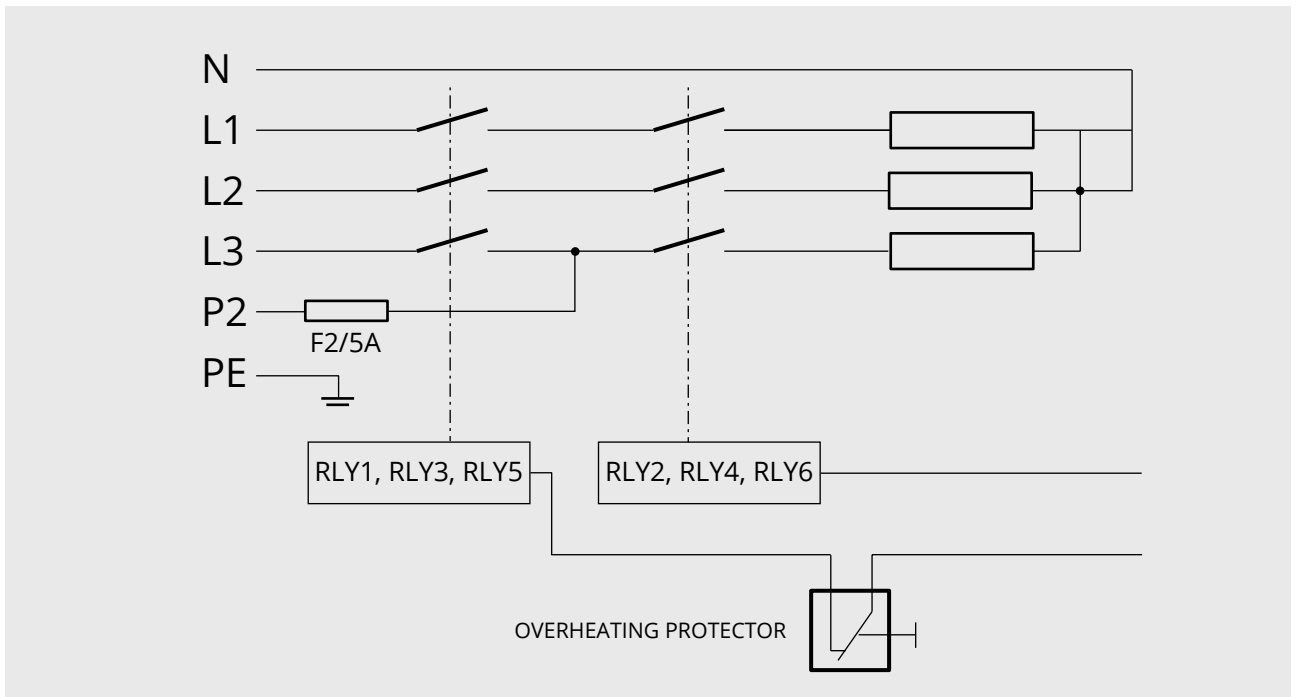

Controller card wiring, heater

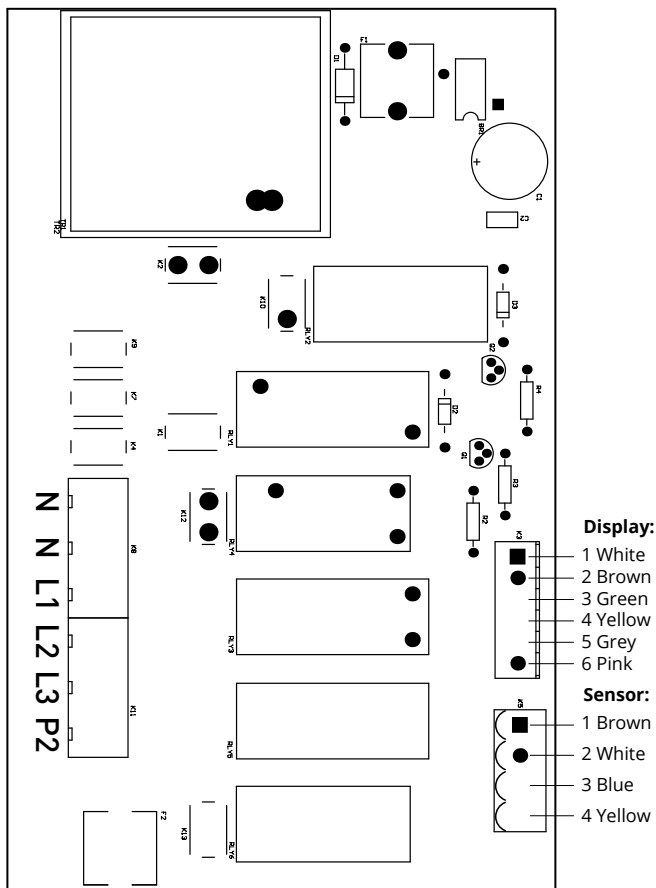

Controller card wiring, controller

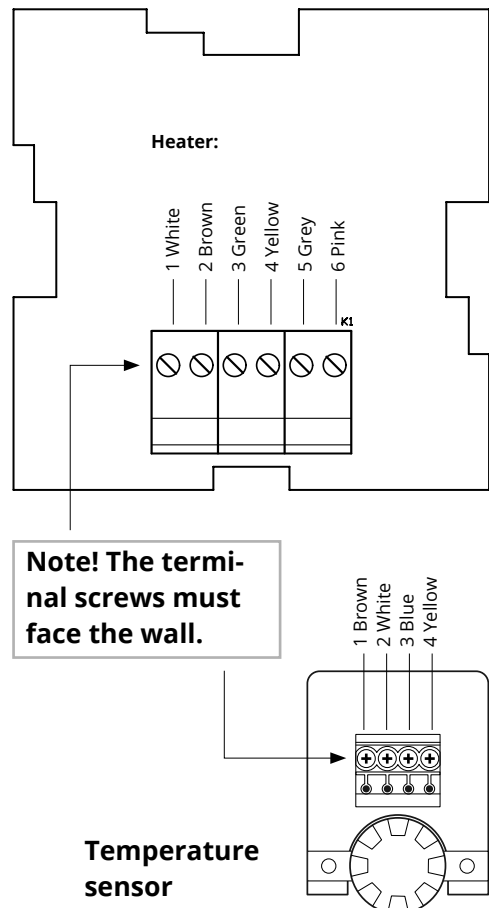

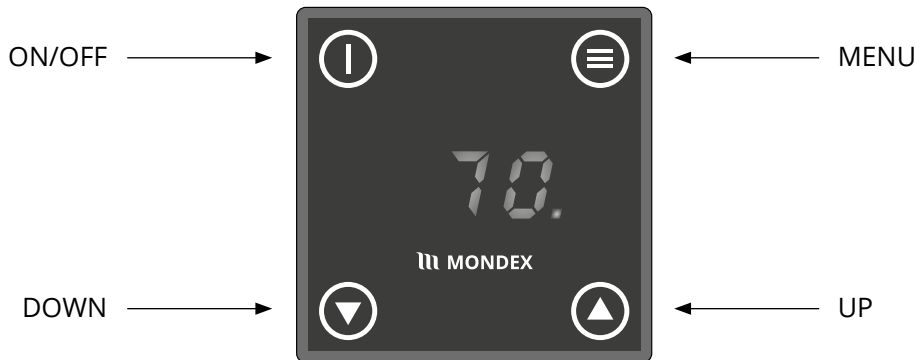

## 10 HEATER CONTROL AND OPERATION



### Switching on the heater

The heater is switched on by pressing the ON/OFF button. 



If three lines appear on the display, the buttons are locked.

The buttons can be unlocked by pressing the ON/OFF and MENU buttons simultaneously until all LED segments on the display are lit (as shown in the picture).  



The heater is switched on by pressing the ON/OFF button again. 

### Starting the heating process

When the heater is switched on, the duration of heating last used is displayed (the default value is 2 hours).

The duration of heating can be changed by using the UP and DOWN buttons, either by repeatedly pressing them briefly or by keeping them depressed longer. The time will change in 30-minute increments.  



The target temperature last used can be displayed by pressing the MENU button. 

The temperature can be changed by using the UP and DOWN buttons, either by repeatedly pressing them briefly or by keeping them depressed longer.  

### Timing of the heating process



The timing setting is displayed by pressing the MENU button again. 

The right-hand decimal point on the display is lit to indicate that the timing setting is displayed.

The setting can be changed by using the UP and DOWN buttons, either by repeatedly pressing them briefly or by keeping them depressed longer. The time will first change in 30-minute increments, and after ten hours, in one-hour increments.  



If the timing has been set and the ON/OFF button is pressed, the timing will start first, and only then the actual heating process. 

During the timing, the right-hand decimal point on the display is blinking to indicate that the timing is in progress.

The timing setting can be changed during the timing process by using the UP and DOWN buttons, either by repeatedly pressing them briefly or by keeping them depressed longer.  

If the timing setting is changed to zero, or the ON/OFF button is pressed during the timing process, the timing process ends, and the heating process starts immediately. 

### Starting the heating

The duration of heating is displayed again by pressing the MENU button one more time. You can now start the heating by pressing the ON/OFF button. The current temperature will be displayed, and the right-hand decimal point on the display is lit to indicate that the heating process is in progress.  

The target temperature can be adjusted by using the UP and DOWN buttons. When the target temperature has been adjusted, the current temperature will again be displayed after a while. The remaining heating time is displayed by pressing the MENU button during the heating process.

The duration of heating can now be changed by using the UP and DOWN buttons, and the current temperature will be displayed when the change has been made. If the duration of heating is changed to zero, the heating stops immediately.

### Stopping the heating or timing process

The heater can be turned off by pressing the ON/OFF button for a while during the heating or timing process or any other state.

### Quick start of the heating process

The heating process can be started quickly by pressing the MENU button. This sets the duration of heating to two hours and the target temperature to the value last used (the default value is 70 °C).

If three lines appear on the display, the buttons are locked. The buttons can be unlocked by pressing the ON/OFF and MENU buttons simultaneously until all LED segments on the display are lit (as shown in the picture).

The heating process can be started by pressing the MENU button again.

### Parental control

The heater has a menu for separately set parameters.

You can enter the menu by pressing the MENU and ON/OFF buttons simultaneously for a while. The abbreviation of the first parameter will be displayed.

The current value of the parameter can be displayed by pressing the MENU button.

You can change the parameter value by using the UP and DOWN buttons.

The chosen parameter value can be saved by pressing the MENU button so that the abbreviation of the parameter is again displayed.

You can leave the menu by pressing the ON/OFF button. This will also switch the heater off.

Parameter	Abbreviation	Value range	Default value
Button locking	---	ON/OFF	ON

### Error codes

When a known fault situation arises, an error code is displayed. It has one of the following meanings:

Error code	Meaning
E01	The overheating protector has tripped
E02	The thermal sensor is out of order
E03	The thermal sensor is not connected

# 11 TROUBLESHOOTING

## HEATER DOES NOT WARM UP

**Check the heater fuses at the fuse box**

**Is the power on?**

**Check that all three heating resistors are glowing then the heater is on**

**Has the overheating protector tripped?**

-> This is reset by pressing the button in the sensor box until a click is heard. The cause of overheating must always be determined before the heater is switched on again! If necessary, contact the dealer or manufacturer.

## WARNINGS

- Due to a risk of fire, do not use the sauna to dry clothes or laundry.
- Exercise caution with a hot heater, since the heater stones and metal parts become very hot and can cause burns.
- The water steam rising from the heater is hot and can cause burns.
- Children, disabled and ill persons who are using the sauna should be supervised.
- Benches and floors may be slippery, therefore move in the sauna with caution.
- Do not go to a hot sauna under the influence of narcotic substances (alcohol, drugs, narcotics, etc.)

## 12 WARRANTY AND MAINTENANCE

### WARRANTY

For heaters and control units in private use, the warranty is two (2) years. In commercial/professional use, the warranty is three (3) months. Commercial use refers to facilities in which the heater is in use on a continuous basis, such as fitness centres, swimming pools, housing companies etc. It is not recommended that the heater is on for longer than six (6) hours at a time. Retain the sales receipt or warranty card. The warranty does not cover external or internal mechanical damage caused by, for example, the impacts of stones or the heater falling over. The warranty also does not cover defects caused by acts of nature, such as lightning, or damage caused by overvoltage. Please also see chapter "Changing the heater stones". **Removing or re-stacking of heater stones are not covered by the warranty in a potential warranty maintenance.** The manufacturer will not compensate the buyer for expenses incurred by a product defect or malfunction, loss caused by disruption of business operations, or any other direct or indirect damage. For more detailed warranty terms and conditions, please see [www.mondex.fi/en/product-support/](http://www.mondex.fi/en/product-support/).

### MAINTENANCE AND SPARE PARTS

In case of a fault that cannot be solved, please contact the store where you purchased the heater or email [info@mondex.fi](mailto:info@mondex.fi). Spare parts can be purchased from Mondex distributors and the manufacturer. When purchasing spare parts, please refer to the name, power, serial number and manufacturing date of the heater to ensure you receive the correct parts.

### NATURAL STONE AS MATERIAL

Small pebbles or pieces may come off the natural stone used in the heater. As this is not a failure of the organic material but a natural feature that cannot be predicted at the time of manufacturing the product, the manufacturer is not responsible for any damage.

### CHANGING THE HEATER STONES

Re-stack the heater stones and replace any eroded stones annually, more often if used intensively (every three months in commercial/professional use). The good condition and proper, spacious stacking of the stones around the resistors inside the heater ensure a sufficient air flow between the resistors. **If this is not done annually, proper air flow may be obstructed and the resistors may fail prematurely; this is not covered by the warranty.**

